

Spherical roller bearings, cylindrical and tapered bore

Principal dimensions			Basic load ratings		Speed ratings	Limiting speed	Designation
d	D	B	dynamic C	static C0	Reference speed		* SKF Explorer bearing
mm			kN		r/min		-
220	340	90	1261	1860	1600	2000	23044 CCK/W33 *

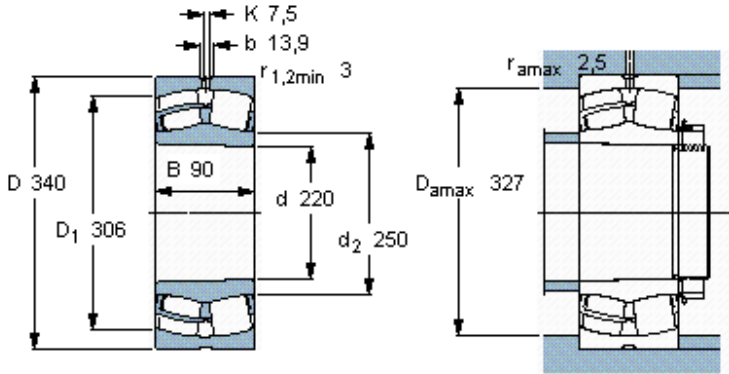

Tapered bore, taper
1: 12

Calculation factors

- e 0,24
- Y_1 2,8
- Y_2 4,2
- Y_0 2,8